



4" Smart Valve Cut Sheet

Materials

Acetron GP

Stainless Steel

Aluminum (flange – no water or pipe contact)

FDA approved internal o-rings

Certifications

NSF 61 (potable water)

NSF 372 (lead free)

Certifying laboratory: IAPMO R&T

Installation Dimensions

4" SMART VALVE:

Body Length – Flange to Flange

8.05"

Approximate Weight

15 lbs

Bolt Pattern

Standard

Bolt Holes

Through Holes

Shipping Weight

16 lbs

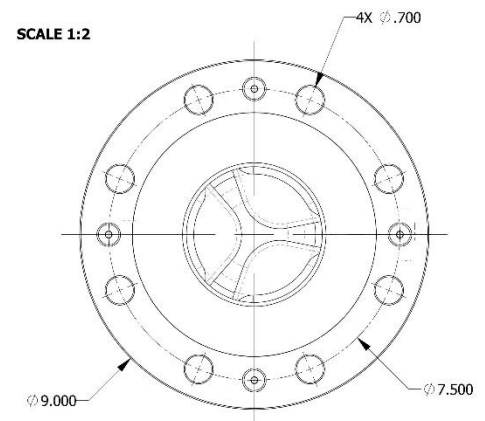
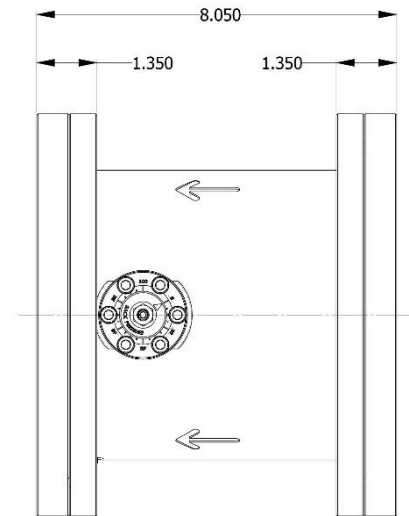

For best results install the Smart Valve downstream of water meter and backflow preventer (if present), but before any other equipment such as a pressure reducer or booster pump. Where *possible* it is recommended (but not critical) to have 10 diameters of pipe between the water meter and the valve. All flanged installations to use gaskets at each flange.

IMPORTANT: If the pipe the Smart Valve is being installed in is used as a Ground Fault Line, The Smart Valve will NOT conduct a current through the pipe without a grounding strap. As a precaution, ALWAYS use a ground strap across the valve from pipe to pipe.